

RYOBI RHT25X60RO

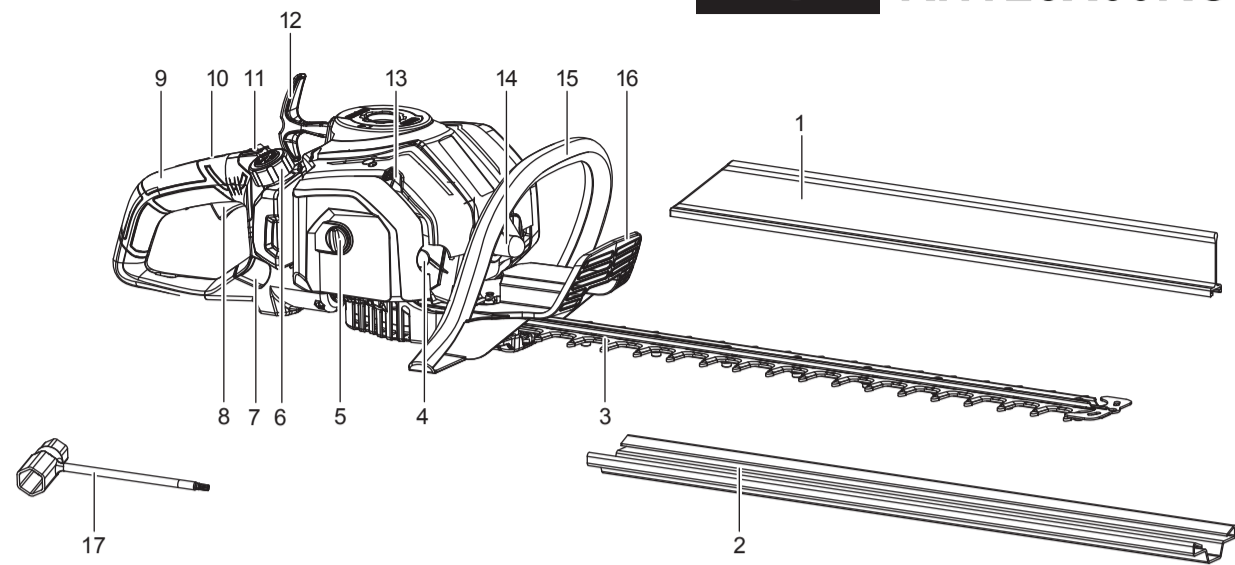

Fig. 1

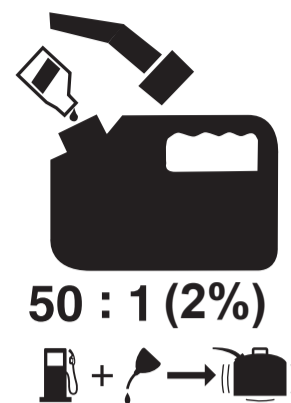

Fig. 2

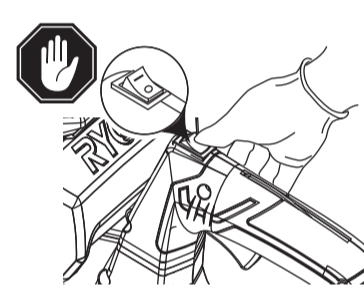
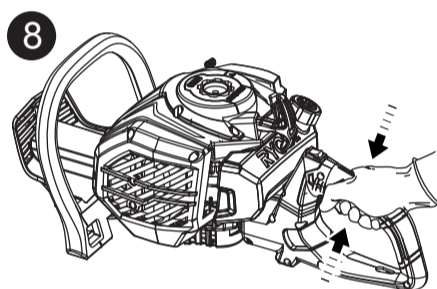
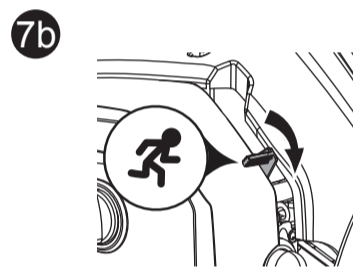
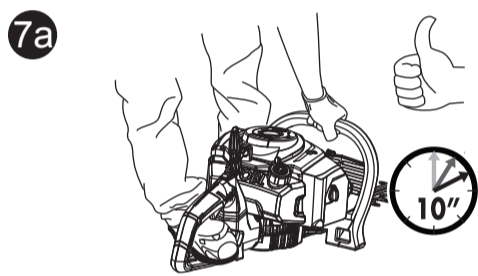
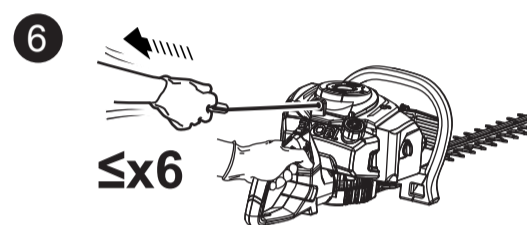
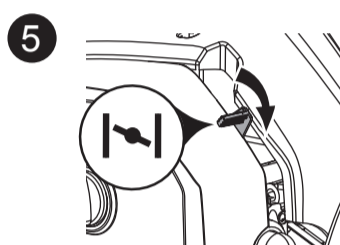
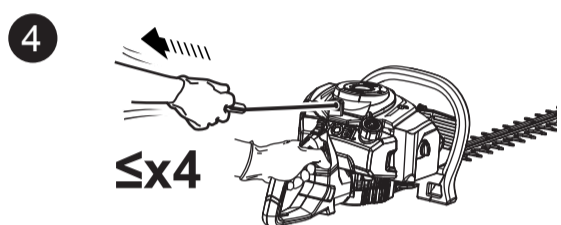
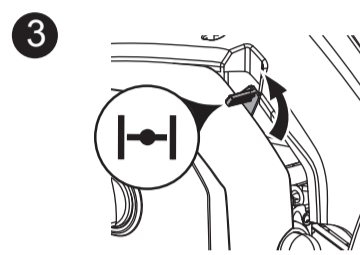
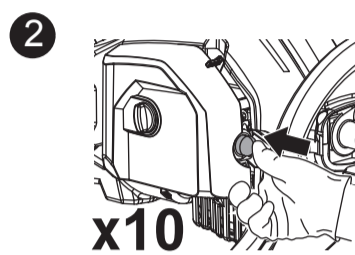

Fig. 3a

RYOBI RHT25X60RO

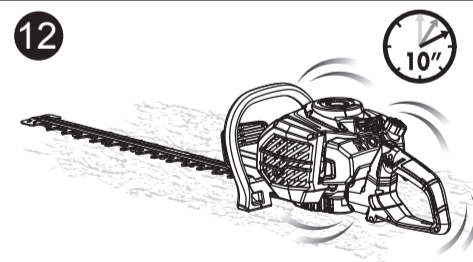
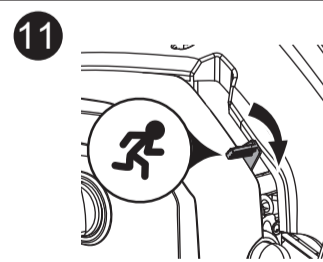
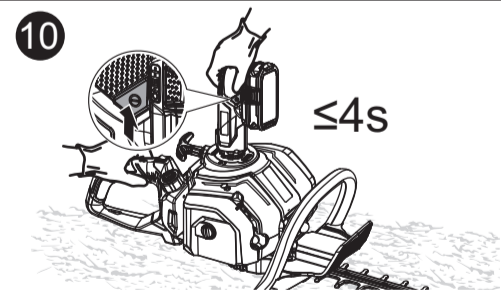
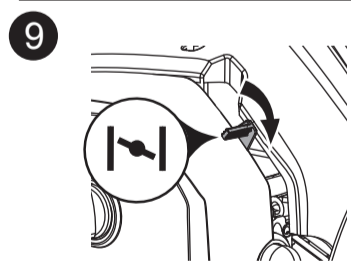
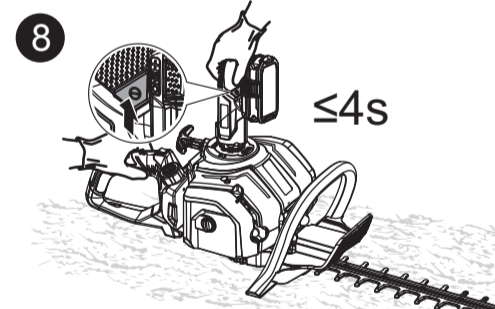
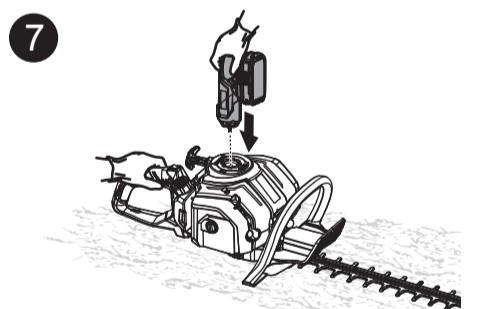
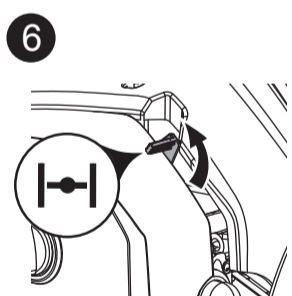
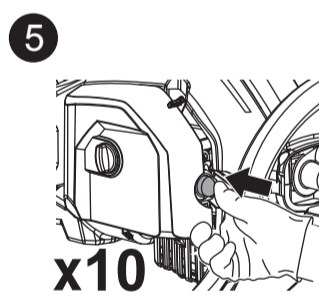
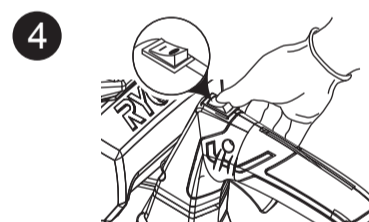
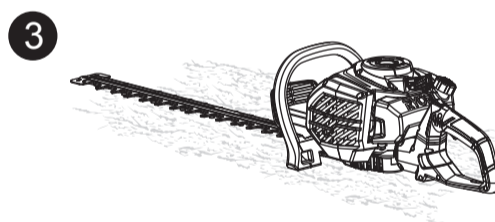
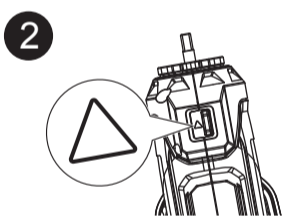
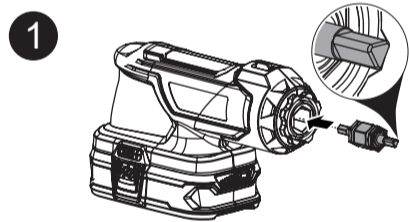

Fig. 10a

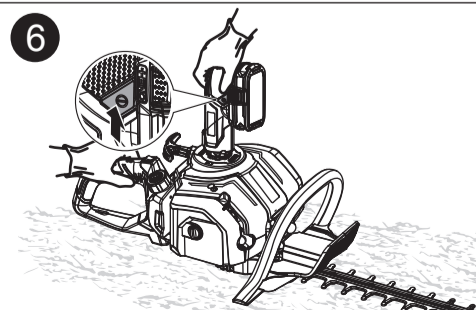
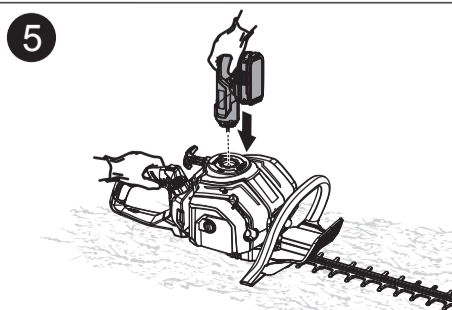
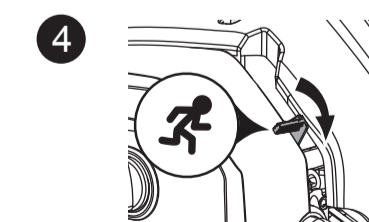
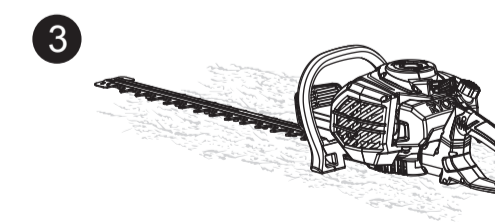
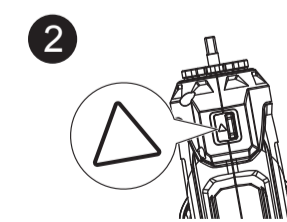
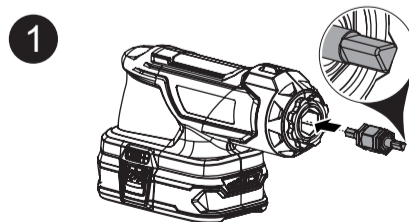

Fig. 10b

RYOBI RHT25X60RO

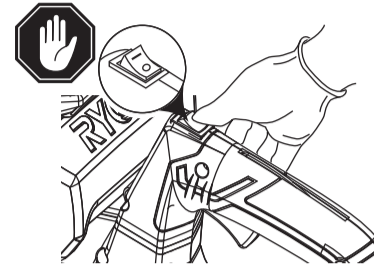
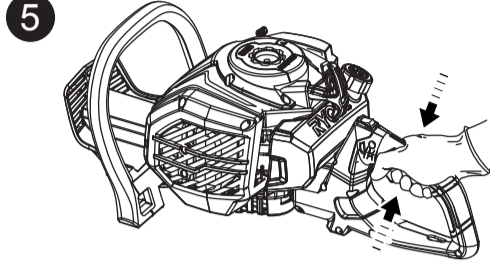
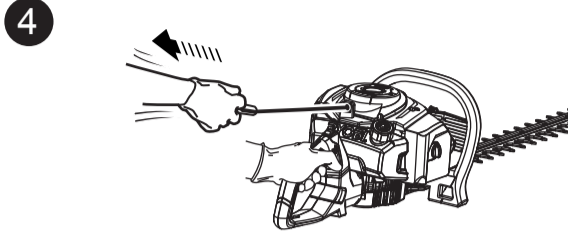
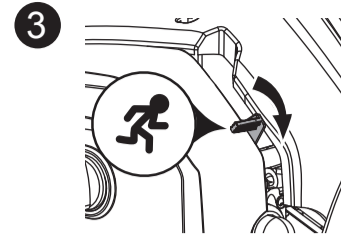
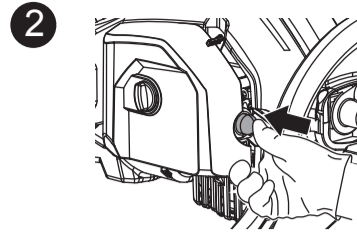
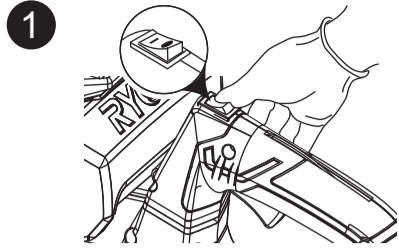
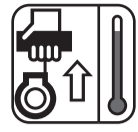

Fig. 3b

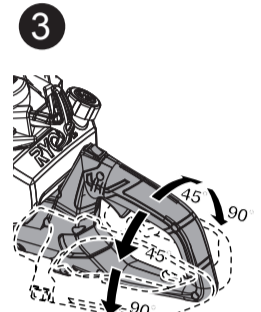
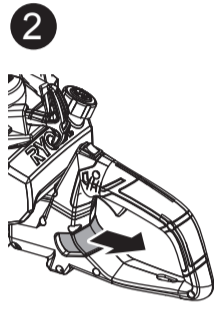

Fig. 4

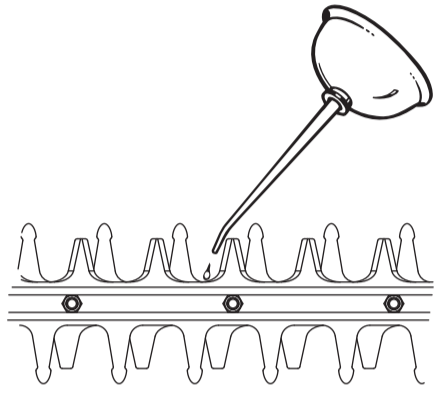

Fig. 5

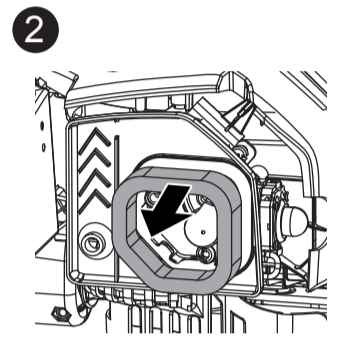
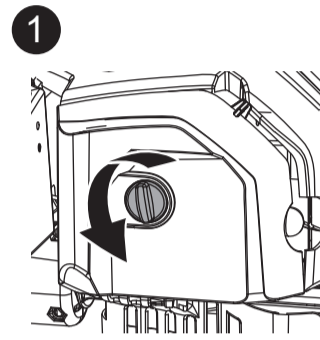

Fig. 6

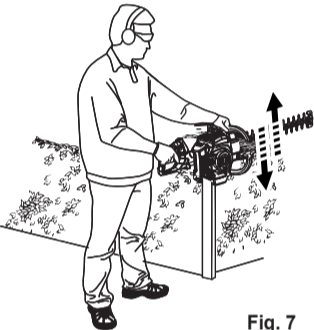
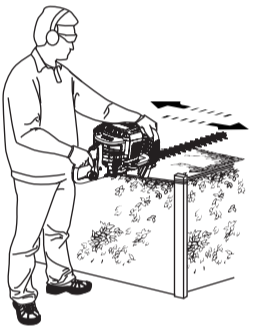

Fig. 7

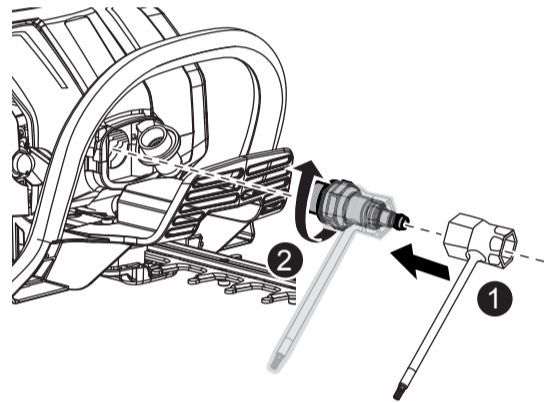

Fig. 8

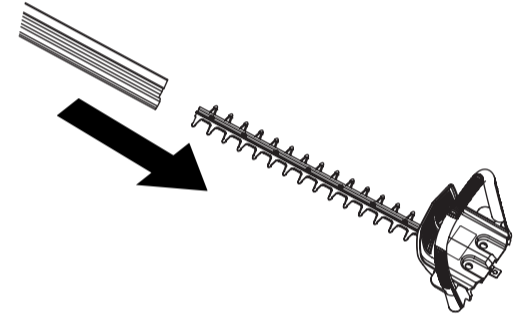

Fig. 9